



### Step 1: Materials Needed for an OEM Assembly



- 1. OEM Printed Circuit Board
- 2. Silicone Rubber Keypad Overlay
- 3. Cable
- 4. Silicone RTV Glue

### Step 2: Applying Adhesive to Silicone Overlay

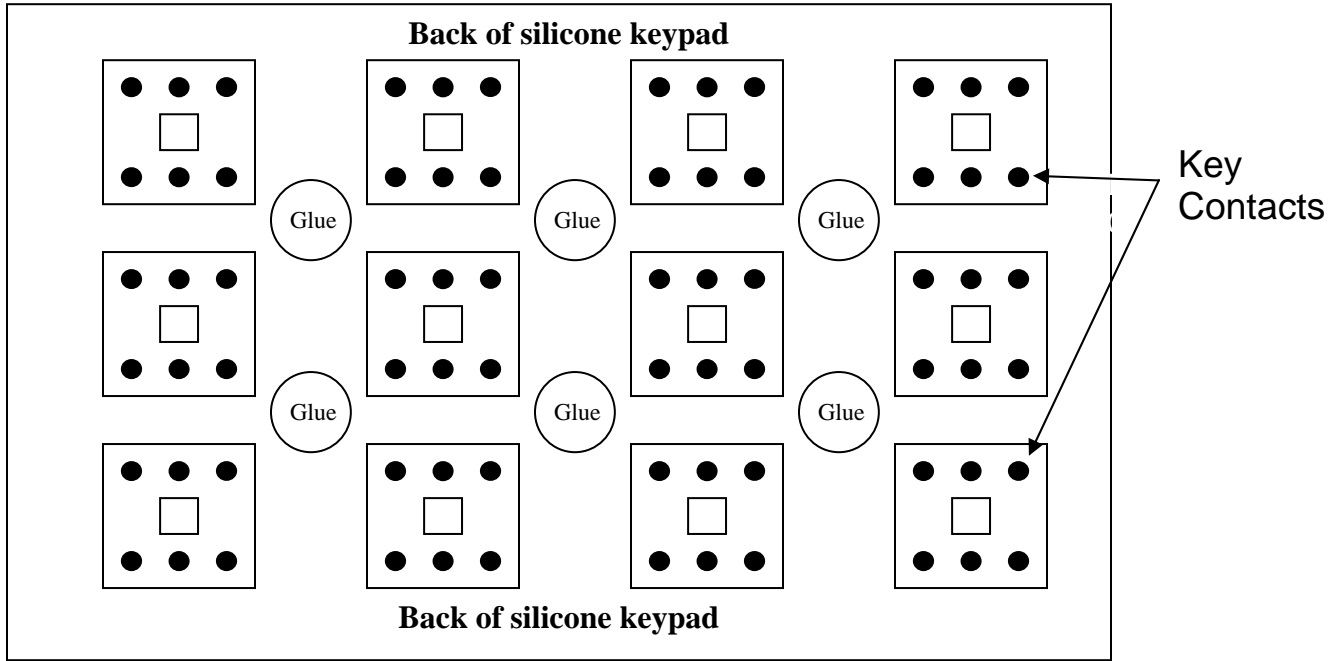

Apply silicone adhesive [Stealth recommends SuperFlex by Loctite] to back side of silicone overlay (keypad). Sparingly dab glue on the middle of each key intersection across the whole keyboard as seen in this picture. Also apply to inside of center portion of HulaPoint™ pad (where the sensor/joystick lies) if OEM kit incorporates the HulaPoint™

**Be careful not to drop silicone on any key contacts.**

## INCORRECT GLUING PROCEDURE

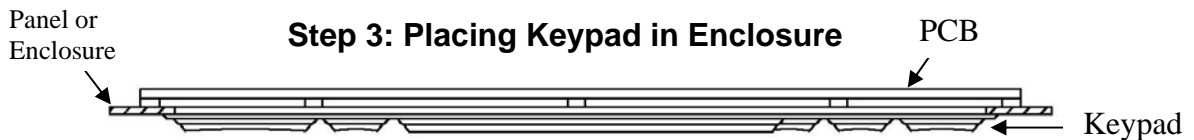
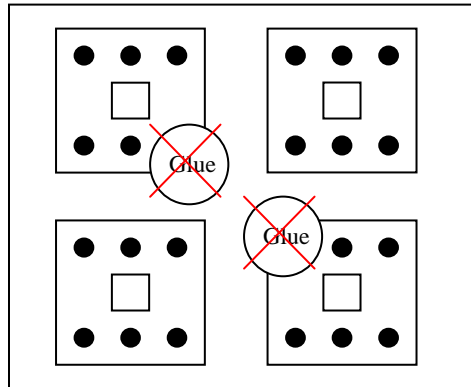

### Step 3: Placing Keypad in Enclosure

1. Put the silicone rubber keypad into place on the panel or enclosure you are using. Do not place PCB yet.
2. Seat the keypad in the mounting cutout by sliding one edge at a time into the cutout space.
3. Spread the keypad to be sure it is well seated on all four sides. Ensure that the lip is through the cutout all the way around the pad.
4. When the keypad is in place, gently allow the board to fall into place on top of the keypad so no glue is displaced onto a key trace, or key contact. (**Note:** make sure the PCB and pad are oriented in the same direction.)

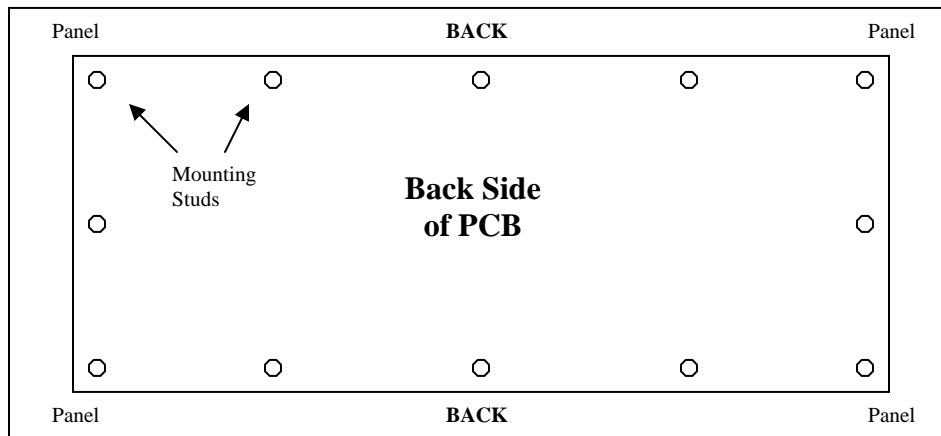

5. Tighten hex nuts until keypad is just SLIGHTLY compressed between panel and PCB. We recommend 1.5 in/lbs. of torque when tightening.
6. Run fingers between all keys to ensure a good silicon and PCB bond.
7. Allow glue to cure for 1 hour

## Step 4: Wiring for Keyboard

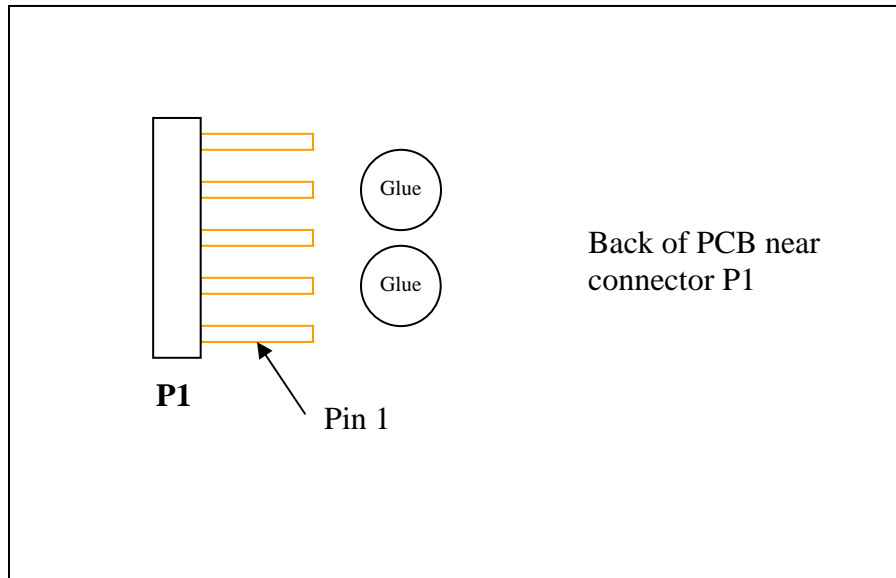

Add a dab or two of glue on the PCB just in front of the connector so that the cable header will sit on the glue when connected to the board and make itself more secure. The picture above illustrates the placement of the glue prior to the connection

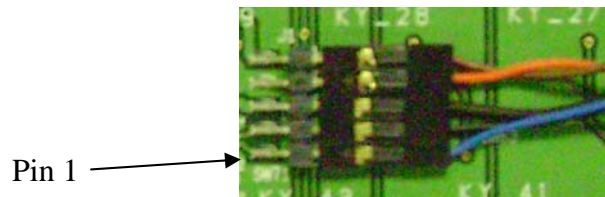

**PS/2 or USB Cables:** Blue, Glossy Black, Dull Black, Red, Brown

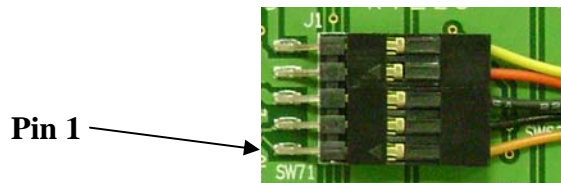

**Standard Cable:** Orange, Glossy Black, Dull Black, Red, Yellow

## Custom Cables Signal Layout

<b>Keyboard</b>	
J1 (1x5 Header)	
<b>PIN</b>	<b>Connectivity Function</b>
1	Clock
3	Data
5	Chassis Ground
7	Signal Ground
9	Power (+5 VDC)

Next, connect the cable onto the prongs of J1 as shown above.

Your Stealth keyboard is now ready to use with your setup.

If you should have any additional questions, please feel free to contact Stealth Computer directly at 1-888-STEALTH or local at: 905-264-9000.